



M1.1 SCOPE.

M1.1.1. Purpose. The scope of this SECTION is to present the information required by a draftsman or engineer to enable him to create a metric drawing, or to convert an existing inch drawing to a metric drawing.

M1.2 APPLICABLE DOCUMENTS. Note: DoD Policy Memo 05-3 “Elimination of Waivers to Cite Military Specifications and Standards in Solicitation and Contracts” has eliminated the need for waivers to use MIL-SPECS and MIL-STDS on DoD contracts. (See PREFACE 1, Section 2)

FED-STD-376	Preferred Metric Units for General Use by the Federal Government
ISO 1000	SI Units and Recommendations for the Use of Their Multiples and of Certain Other Units
NBS MISC PUB 286	Units of Weights and Measures
NIST SP 330	The International Systems of Units (SI)
NASA SP 7012	The International System of Units Physical Constants and Conversion Factors
ANSI/IEEE STD 268	American National Standard for Metric Practice (CNCLD Supsed by: ASTM/IEEE SI 10)
IEEE/ ASTM SI 10	Standard For Use of the International System of Units
AIIM TR01	Guidelines for Metric

M1.3 DEFINITIONS. (U.S. BUREAU OF STANDARDS)

M1.3.1 Unit Of Length.

M1.3.1.1 Meter. The meter is the length equal to 1 650 763.73 wavelengths in vacuum of the radiation corresponding to the transition between the levels $2p_{10}$ and $5d_5$ of the krypton -86 atom.

M1.3.2 Unit Of Mass.

M1.3.2.1 Kilogram. The kilogram is the unit of mass of the international prototype of the kilogram: a platinum-iridium alloy cylinder, kept by the International Bureau of Weights and Measures near Paris, France.

M1.3.3. Unit Of Time.

M1.3.3.1 Second. The second is the duration of 9 192 631 770 periods of the radiation corresponding to the transition between the two hyperfine levels of the ground state of the cesium 133 atom.

M1.3.4 Unit Of Electric Current.

M1.3.4.1 Ampere. The ampere is that constant current which, if maintained in two straight parallel conductors of infinite length, of negligible circular cross section, and placed one meter apart in a vacuum, would produce between these conductors a force equal to 2×10^{-7} newtons per meter of length.



M1.3.5 Unit Of Thermodynamic Temperature.

M1.3.5.1 Kelvin. The Kelvin (the SI unit of thermodynamic temperature) is the fraction $1/273.16$ of the thermodynamic temperature of the triple point of water.

M1.3.6 Unit Of Amount Of Substance.

M1.3.6.1 Mole. The mole is the amount of substance of a system which contains as many elementary entities as there are atoms in 0.012 kilogram of carbon 12. The elementary entities must be specified and may be atoms, molecules, ions, electrons, other particles, or specified groups of such particles.

M1.3.7 Unit Of Luminous Intensity.

M1.3.7.1 Candela. The candela is the luminous intensity, in the perpendicular direction, of a surface of $1/600\,000$ square meter of a black body at the temperature of freezing platinum under a pressure of 101 325 newtons per square meter.

M1.3.8 Unit of Plane Angle

M1.3.8.1 Radian. The radian is the plane angle between two radii of a circle which cut off on the circumference an arc equal in length to the radius of the sphere. See FIGURE M1-1.

M1.3.9 Unit Of Solid Angle.

M1.3.9.1 Steradian. The steradian is the solid angle which, having its vertex in the center of a sphere, cuts off an area of the surface of the sphere equal to that of a square with sides of length equal to the radius of the sphere. See FIGURE M1-2.

M1.4 SI- SYSTEM OF INTERNATIONAL UNITS.

M1.4.1 SI-System Of International Units. SI was created, and is controlled by the General Conference of Weights and Measures-an International Treaty Organization. SI was established to provide a system of well defined, coordinated units for science and industry, which would be the international language of measurement.

M1.5 SI UNITS.

M1.5.1 Classes Of Units. There are three classes of units in the international system:

- a. BASE UNITS
- b. SUPPLEMENTARY UNITS
- c. DERIVED UNITS



M1.5.1.1 Base Units. The seven base units are:

- a. The meter - the unit of length
- b. The kilogram - the unit of mass
- c. The second - the unit of time
- d. The ampere - the unit of electric current
- e. The kelvin - the unit of thermodynamic temperature
- f. The mole - the unit of amount of substance
- g. The candela - the unit of luminous intensity

SYMBOL

- m
- kg
- s
- A
- K
- mol
- cd

The seven base units are defined in PARAGRAPHS M1.3.1 through M1.3.7.

M1.5.1.2 Supplementary Units. The two supplementary units are:

- a. The radian - the unit of plane angle
- b. The steradian - the unit of solid angle

SYMBOL

- rad
- sr

The two supplementary units are defined in PARAGRAPHS M1.3.8 and M1.3.9 and illustrated in FIGURES M1-1 and M1-2.

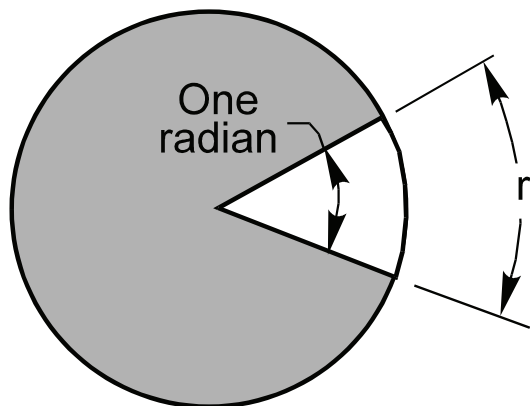

RADIAN
FIGURE M1-1

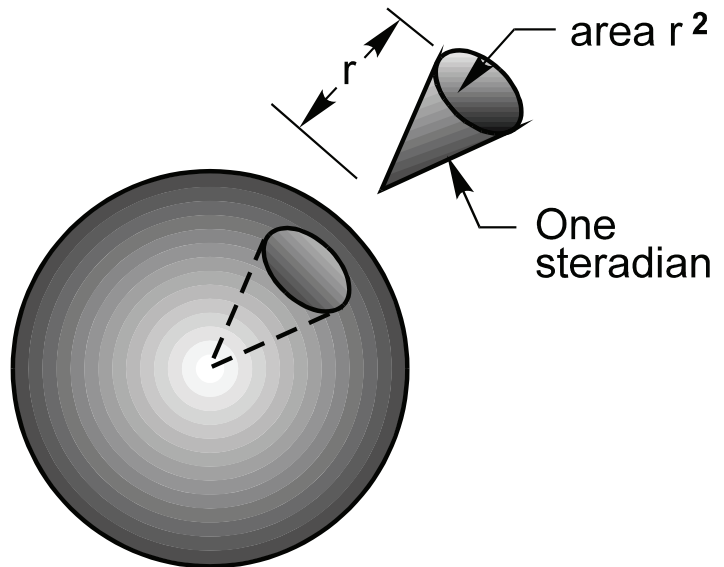

STERADIAN
FIGURE M1-2



M1.5.1.3 Derived Units. Derived units are formed from base and supplemental units by multiplying, dividing, or raising the units(s) to a positive or negative power. See TABLE M1-1.

QUANTITY	UNIT	SYMBOL	DERIVATION
Area	square meter	m ²	
Volume	cubic meter	m ³	
* Frequency	hertz	Hz	1/s
Density, mass	kilogram per cubic meter	kg/m ³	
Velocity	meter per second	m/s	
Angular velocity	radian per second	rad/s	
Acceleration	meter per second squared	m/s ²	
Angular acceleration	radian per second squared	rad/s ²	
* Force	newton	N	kg • m/s ²
* Pressure, Stress,	pascal	Pa	N/m ²
Viscosity, kinematic	square meter per second	m ² /s	
Viscosity, dynamic	pascal second	Pa • s	
* Energy, work, qty of heat	joule	J	N • m
* Power, radiant flux	watt	W	J/s
* Electric charge, qty of electricity	coulomb	C	A • s
* Voltage	volt	V	W/A
Electric field strength	volt per meter	V/m	
* Electric resistance	ohm	Ω	V/A
* Electric capacitance	farad	F	C/V
* Magnetic flux	weber	Wb	V • s
* Electric inductance	henry	H	Wb/A
* Magnetic flux density	tesla	T	Wb/ m ²
Magnetic field strength	ampere per meter	A/m	
* Magnetomotive force	ampere	A	
Luminous flux	lumen	lm	cd • sr
Luminance	candela per square meter	cd/m ²	
* Illumination	lux	lx	lm/m ²

* Derived SI units with special names and symbols

COMMON DERIVED SI UNITS
 TABLE M1-1



M1.6 NON-SI UNITS

M1.6.1 Non SI Units Which May Be Used With SI. There are certain useful units of measurements which are not SI units, but are recognized, and may be used with SI. These units are:

- a. degree (of angle)
- b. degree Celsius (temperature)
- c. decibel
- d. minute
- e. hour
- f. day
- g. month
- h. year
- i. liter

M1.7 OBSOLETE UNITS AND PREFIXES.

M1.7.1 Obsolete Units And Prefixes Which Are To Be Avoided.

- a. Erg
- b. Dyne
- c. Poise
- d. Stokes
- e. Gauss
- f. Oersted
- g. Maxwell
- h. Stilb
- i. Phot
- j. Micron
- k. Myria
- l. Fermi
- m. Metric Carat
- n. Torr
- o. Kilogram-force
- p. Calorie
- q. Stere

M1.7.2 Centigrade. The word “centigrade” (relative to temperature) has been obsolete since 1948. The proper term is “Celsius” or “degree Celsius”.



M1.8 SI PREFIXES.

M1.8.1 SI Unit-Multiples And Unit-Submultiples. SI unit-multiples and unit-submultiples are designated by adding a prefix to the unit's name.

M1.8.2 Multiplying Value Of The Prefix. The prefix and its multiplying value are shown in TABLE M1-2.

PREFIX NAME	SYM	PREFIX VALUE	MULTIPLICATION FACTOR	SCIENTIFIC NOTATION
yotta	Y	one million million million million times	1 000 000 000 000 000 000 000 000	10 ²⁴
zetta	Z	one thousand million million million times	1 000 000 000 000 000 000 000	10 ²¹
exa	E	one million million million times	1 000 000 000 000 000 000	10 ¹⁸
peta	P	one thousand million million times	1 000 000 000 000 000	10 ¹⁵
tera	T	one million million times	1 000 000 000 000	10 ¹²
giga	G	one thousand million times	1 000 000 000	10 ⁹
mega	M	one million times	1 000 000	10 ⁶
kilo	k	one thousand times	1 000	10 ³
hecto*	h	one hundred times	100	10 ²
deka*	da	ten times	10	10 ¹
unit name		one time	1	
deci*	d	one tenth of	0.1	10 ⁻¹
centi*	c	one hundredth of	0.01	10 ⁻²
milli	m	one thousandth of	0.001	10 ⁻³
micro	μ	one millionth of	0.000 001	10 ⁻⁶
nano	n	one thousandth millionth of	0.000 000 001	10 ⁻⁹
pico	p	one millionth millionth of	0.000 000 000 001	10 ⁻¹²
femto	f	one thousandth millionth millionth of	0.000 000 000 000 001	10 ⁻¹⁵
atto	a	one millionth millionth millionth of	0.000 000 000 000 000 001	10 ⁻¹⁸
zepto	z	one thousandth millionth millionth millionth of	0.000 000 000 000 000 000 001	10 ⁻²¹
yocto	y	one millionth millionth millionth millionth of	0.000 000 000 000 000 000 000 001	10 ⁻²⁴

* Avoid using these multiples and submultiples whenever possible. Prefixes representing steps of 1000 are recommended.

SI PREFIXES
 TABLE M1-2

M1.9 SI SYMBOLS.

M1.9.1 Importance Of Upper And Lower Case Letters. All branches of knowledge use symbols. Consequently certain letters may have one meaning when written as an upper case letter and a different meaning when written in lower case. Consequently, care must be taken to use the correct symbol, properly! See TABLES M1-3, M1-4, M1-5 and M1-6.



M1.9.2 Symbols Identified By Upper Case Letters. TABLES M1-3 and M1-4 show symbols which are written in capital letters:

UNIT NAME	PROPERTY	INDIVIDUAL HONORED	SYM
ampere	electric current	Andre Ampere	A
degree Celsius	Celsius temperature	Anders Celsius	°C
coulomb	quantity of electricity	Chas. de Coulomb	C
farad	electric capacitance	Michael Faraday	F
henry	inductance	Joeseph Henry	H
hertz	frequency	Heinrich Hertz	Hz
joule	energy	James Joule	J
kelvin	absolute temperature	Wm. (Lord) Kelvin	K
newton	force	(Sir) Isaac Newton	N
ohm	electrical resistance	George Simon Ohm	Ω
pascal	Pressure, stress	Blaise Pascal	Pa
siemens	electrical conductance	Werner von Siemens	S
tesla	magnetic flux density	Nikola Tesla	T
volt	electromotive force	Alessandro (Count) Volta	V
watt	power	James Watt	W
weber	magnetic flux	Wilheim Weber	Wb

SYMBOLS SHOWN IN UPPER CASE LETTERS
 TABLE M1-3

M1.9.2.1 Proper/Common Noun Implication On Metric Unit Identification. Although a person's name is begun with an upper case letter, with the exception of Celsius, that same name is written with lower case letters when the name is used as a unit's name.

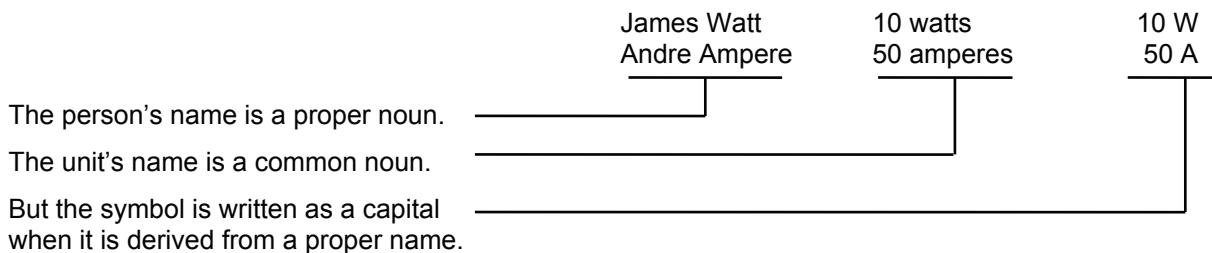

M1.9.2.2 Degree Celsius Symbol. The unit, degree Celsius is a compound symbol: °C. Celsius (both name and symbol) require a capital "C".

M1.9.2.3 Multi-Letter Symbols. When writing the multi-letter symbols Hz, Pa, and Wb, capitalize the first letter.



M1.9.2.4 Upper Case (Capital) Letter Symbols. There are eight prefix symbols, which are written with upper case letters. See M1-4.

PREFIX	SYMBOL
yotta	Y
zetta	Z
exa	E
peta	P
tera	T
giga	G
mega	M
liter	L

NOTE: liter was changed to a capitol “L” by IEEE STD 260-1977.

PREFIX SYMBOLS SHOWN IN CAPITAL LETTERS
 TABLE M1-4

M1.9.3 Lower Case Letter Symbols. TABLE M1-5 and TABLE M1-6 present symbols for units and prefixes which are written in lower case letters.

UNIT NAME	SYMBOL
meter	m
kilogram	Kg
second	s
mole	mol
candela	cd
radian	rad
steradian	sr
minute	min
hour	h
day	d

SYMBOLS SHOWN IN LOWER
CASE LETTERS
 TABLE M1-5

PREFIX NAME	SYMBOL
kilo	k
hecto	h
deka	da
deci	d
centi	c
milli	m
micro	μ
nano	n
pico	p
femto	f
atto	a
zepto	z
yocto	y

PREFIX SYMBOLS SHOWN IN LOWER
CASE LETTERS
 TABLE M1-6

M1.9.4 Combined Symbols. Prefix and unit combinations shall be indicated by combining the appropriate symbols. Proper use of upper and lower case letters shall be observed in order to preserve the integrity of the symbols.











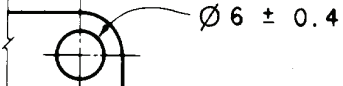
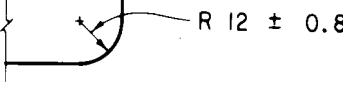
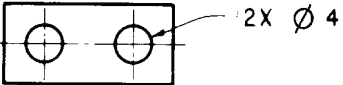

Examples:

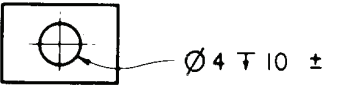
Megahertz MHz
 Kiloohertz kHz
 Kilometer km

Other examples of combined symbols can be seen in TABLE M1-7.

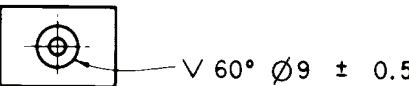
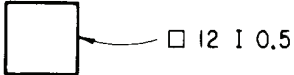
M1.9.5. Symbol Presentation. Symbols are not abbreviations. Consequently they are not followed by a period or a plural “s”.

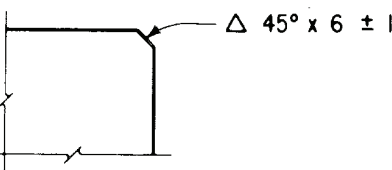
M1.10 SI DRAFTING SYMBOLS.

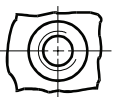
SYMBOL	COMMENT	EXAMPLE
	Square section	
\varnothing	Diameter	
R	Radius	
X	Times or places. Used to indicate repetitive features.*	
	Depth. Replaces the use of depth.	
	Counterbore or spotface	
	Countersink	
I	Thick or thickness	
	Chamfer	
	Tapped hole	} SEE FIGURES M1-3 & M1-4
	Counterbored tapped hole	

* Use a capitalized "X" to indicate repetitive features
 Use a lowercase "x" for the dimensional joiner "by"
 Do not use to indicate material quantities

SI DRAFTING SYMBOLS
 TABLE M1-7

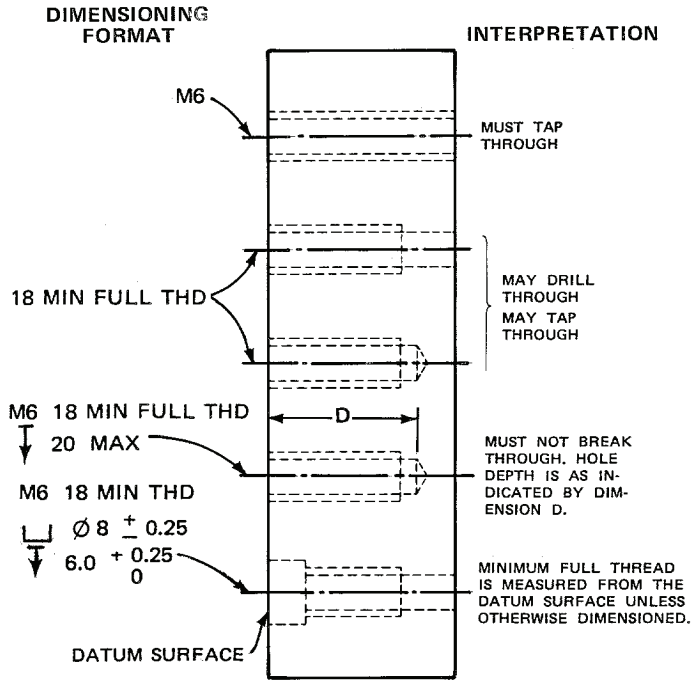

DIMENSIONING FORMAT
FIGURE M1-3

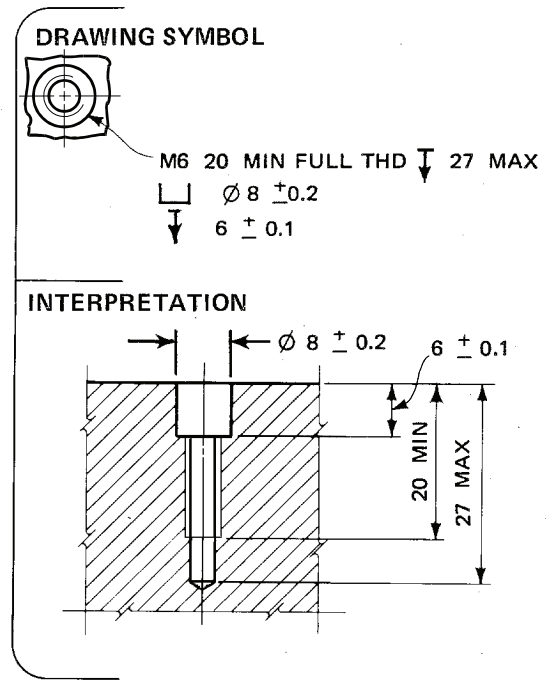

DRAWING SYMBOL
FIGURE M1-4